

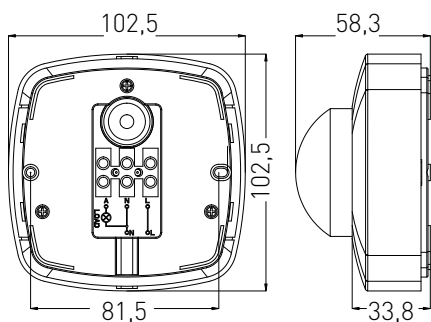









SENSOR 65/66



- KORIDOROVÉ POHYBOVÉ ČIDLO
- pohybové ovládání svítidel
- snímání dlouhých, úzkých prostor
- prachotěsné a voděodolné (GXSE012)
- možnost regulace:
 - čas (TIME)
 - nastavení (noc/den) (LUX)
- spínací prvek - RELÉ
- maximální zatížení 2000W (PF≈1)
- spolupracuje s LED svítidly

-  220-240V-50/60Hz
-  max.8,5A 2000VA-
- 
- 
-  -20+40°C
-  1/50
- 
- 









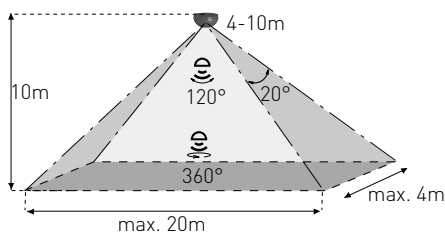
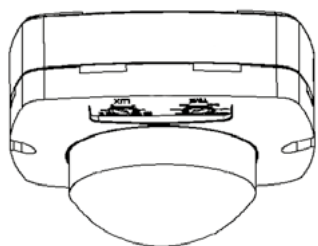



GXSE012



GXSI010



									
SENSOR 65	GXSE012	8592660123158	bílá	360	max. 10m	10s-30min	3-2000	65	158
SENSOR 66	GXSI010	8592660123165	bílá	360	max. 10m	10s-30min	3-2000	20	140